

01.01 Shim-Abstimmplatten

- Katalog -

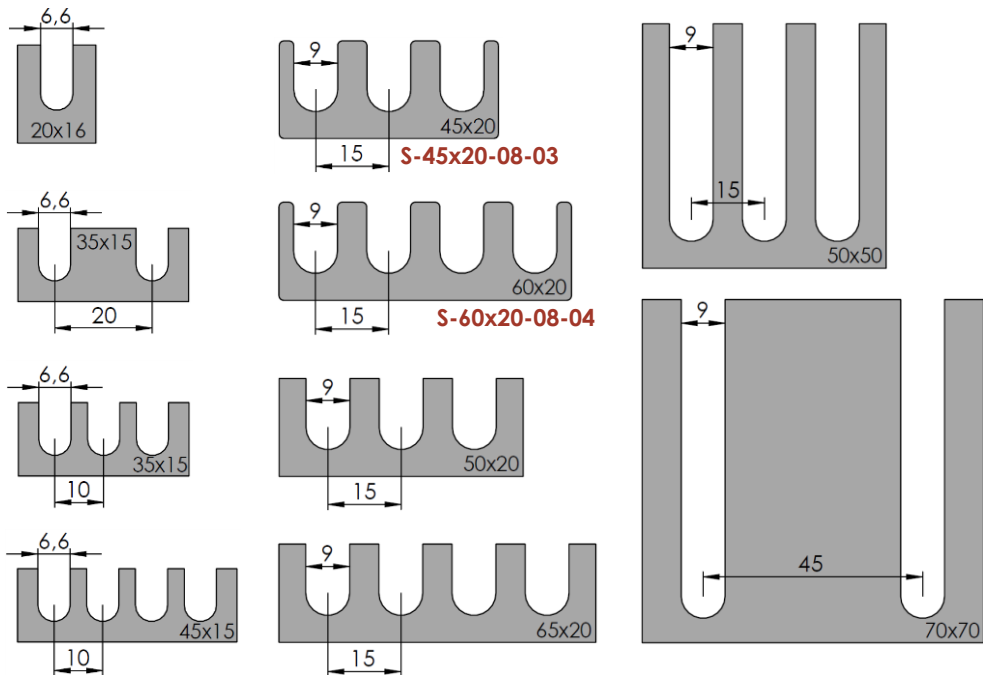

- Auszug Lieferprogramm -

- + Standardshim für Audi - BMW - Daimler - GM - VW - Honda - Skoda ...
- + für die Konstruktion und den Vorrichtung- und Sondermaschinenbau
- + alle Shim- Abstimmplatten lagernd / Lieferzeit: 3 -4 Werktage
- + Stichmaße 10 mm / 15 mm / oder individuell
- + von 0,02 mm - 5,00 mm Blechstärke lieferbar
- + lieferbare Werkstoffe: Edelstahl (Standard) / Stahl / ...
- + Standardkontur oder individuell nach DXF-Daten
- + Shimbleche und Shimpakete lieferbar
- + hohe Stückzahlen lieferbar

Werkstoffe:

Edelstahl (VA) (Standard) / Vorteil: korrosionsbeständig
 von **0,02 mm** bis **0,4 mm** (aus 1.4310 / Federstahl)
 von **0,5 mm** bis **5,0 mm** (aus 1.4301)

Stahl (ST) / ohne Oberflächenbeschichtung

von **0,5 mm** bis **5,0 mm** (aus DC01)

Wir liefern alle Arten von Shim-Abstimmplatten gerne nach Ihren speziellen Wünschen.

01.01 Shim-Abstimmplatten

Bestellschlüssel:
(Standardshim)

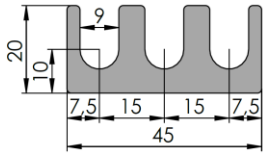

Bestellbeispiel:

Form:	S (Shimblech)
Außenmaß:	45x20 mm
Gewindegröße:	08 (M8)
System:	03 (3 Bohrungen pro Anschraubfläche)
Shimstärke:	01 (t = 0,1 mm)
Werkstoff:	VA (Edelstahl)
Oberfläche:	00 (ohne Oberflächenbeschichtung)
Zubehör:	00 (kein Zubehör)

Form:

- S (Shimblech)
- SP (Shimpaket)
- SD (Shimblech mit Durchgang)
- SDP (Shimblech mit Durchgang Paket)

Gewindegröße:

- 06 (M6)
- 08 (M8)

Shimstärke:

- 005 (0,05 mm)
- 01 (0,1 mm)
- 02 (0,2 mm)
- 05 (0,5 mm)
- 10 (1,0 mm)
- 20 (2,0 mm)
- 50 (5,0 mm)

Oberfläche:

- 00 (ohne Oberflächenbeschichtung)
- BR (brüniert)

S - 45x20 - 08 - 03 - 01 - VA - 00 - 00

Außenmaß:

45x20 mm

System:

- 01 (1 Bohrung pro Anschraubfläche)
- 02 (2 Bohrungen pro Anschraubfläche)
- 03 (3 Bohrungen pro Anschraubfläche)
- 04 (4 Bohrungen pro Anschraubfläche)

Werkstoff:

- VA (Edelstahl)
- ST (Stahl)

Zubehör:

- 00 (kein Zubehör)

01.01 Shim-Abstimmplatten

Auszug Standard-Lieferprogramm:

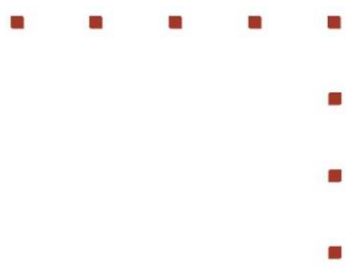
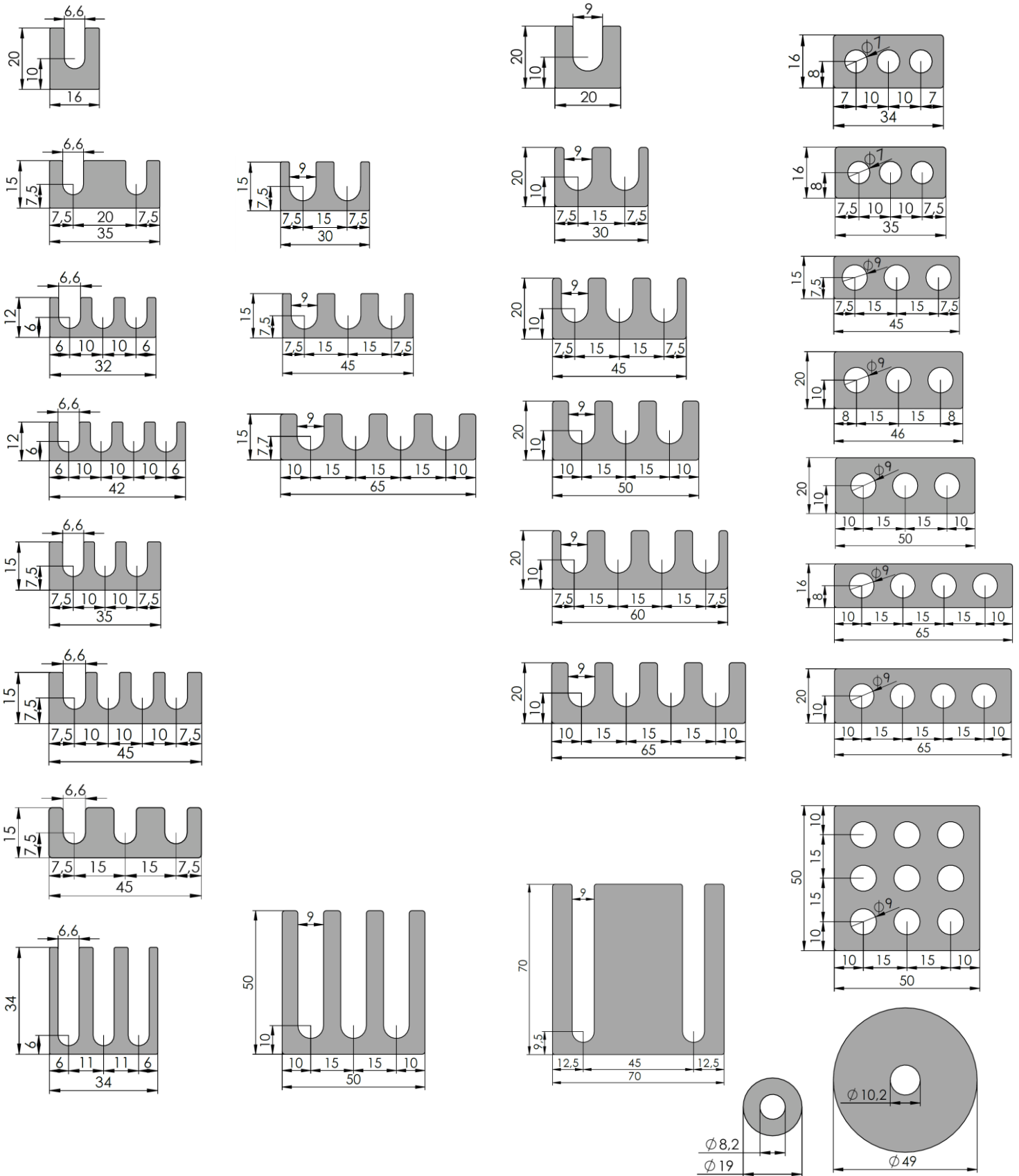

01.01 Shim-Abstimmplatten

Shimblech (S)
Shimpaket (SP)

20x16-06-01

Abmaße identisch

Audi / VW - Norm:

39D 20636/ 1 - 50

11 - 38D 480 956/ 1-7

L = lagernd

NL = nicht lagernd

L/NL Bestellnummer

Dicke

Werkstoff

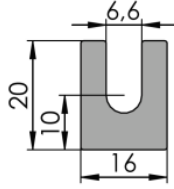

Shimblech (S) Werkstoff: **Edelstahl (VA)**

L	S-20x16-06-01-005-VA-00-00	0,05mm	1.4310
L	S-20x16-06-01-01-VA-00-00	0,1mm	1.4310
L	S-20x16-06-01-02-VA-00-00	0,2mm	1.4310
L	S-20x16-06-01-05-VA-00-00	0,5mm	1.4301
L	S-20x16-06-01-10-VA-00-00	1,0mm	1.4301
L	S-20x16-06-01-20-VA-00-00	2,0mm	1.4301
L	S-20x16-06-01-30-VA-00-00	3,0mm	1.4301
L	S-20x16-06-01-40-VA-00-00	4,0mm	1.4301
L	S-20x16-06-01-50-VA-00-00	5,0mm	1.4301

Shimpaket (SP) Werkstoff: **Edelstahl (VA)**

L	SP-20x16-06-01-30-VA-00-00	3,0mm	1.4301
bestehend aus: 1x 0,1/ 2x 0,2/ 3x 0,5/ 1x 1,0 mm			

Shimpaket (SP) Werkstoff: **Edelstahl (VA)**

L	SP-20x16-06-01-50-VA-00-00	5,0mm	1.4301
bestehend aus: 1x 0,1/ 2x 0,2/ 3x 0,5/ 1x 1,0/ 1x 2,0 mm			

Shimblech (S) Werkstoff: **Stahl (ST)**

L	S-20x16-06-01-05-ST-00-00	0,5mm	DC01
L	S-20x16-06-01-10-ST-00-00	1,0mm	DC01
L	S-20x16-06-01-20-ST-00-00	2,0mm	DC01
L	S-20x16-06-01-30-ST-00-00	3,0mm	DC01
NL	S-20x16-06-01-40-ST-00-00	4,0mm	DC01
L	S-20x16-06-01-50-ST-00-00	5,0mm	DC01

Shimpaket (SP) Werkstoff: **Stahl (ST)**

L	SP-20x16-06-01-30-ST-00-00	3,0mm	DC01
bestehend aus: 1x 0,1/ 2x 0,2/ 3x 0,5/ 1x 1,0 mm			

Shimpaket (SP) Werkstoff: **Stahl (ST)**

L	SP-20x16-06-01-50-ST-00-00	5,0mm	DC01
bestehend aus: 1x 0,1/ 2x 0,2/ 3x 0,5/ 1x 1,0/ 1x 2,0 mm			

01.01 Shim-Abstimmplatten

Abmaße identisch
Audi / VW - Norm:

Shimblech (S)
Shimpaket (SP)

35x15-06-02

11 - 38D 336 075/ 1-7

L = lagernd

NL = nicht lagernd

L/NL Bestellnummer

Dicke

Werkstoff

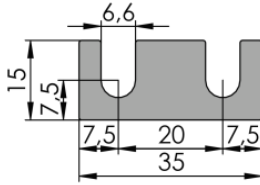

L/NL	Bestellnummer	Werkstoff: Edelstahl (VA)	Dicke	Werkstoff
L	S-35x15-06-02-005-VA-00-00		0,05mm	1.4310
L	S-35x15-06-02-01-VA-00-00		0,1mm	1.4310
L	S-35x15-06-02-02-VA-00-00		0,2mm	1.4310
L	S-35x15-06-02-05-VA-00-00		0,5mm	1.4301
L	S-35x15-06-02-10-VA-00-00		1,0mm	1.4301
L	S-35x15-06-02-20-VA-00-00		2,0mm	1.4301
NL	S-35x15-06-02-30-VA-00-00		3,0mm	1.4301
NL	S-35x15-06-02-40-VA-00-00		4,0mm	1.4301
NL	S-35x15-06-02-50-VA-00-00		5,0mm	1.4301

L/NL	Bestellnummer	Werkstoff: Edelstahl (VA)	Dicke	Werkstoff
L	SP-35x15-06-02-30-VA-00-00		3,0mm	1.4301
bestehend aus: 1x 0,1/ 2x 0,2/ 3x 0,5/ 1x 1,0 mm				

L/NL	Bestellnummer	Werkstoff: Edelstahl (VA)	Dicke	Werkstoff
L	SP-35x15-06-02-50-VA-00-00		5,0mm	1.4301
bestehend aus: 1x 0,1/ 2x 0,2/ 3x 0,5/ 1x 1,0/ 1x 2,0 mm				

L/NL	Bestellnummer	Werkstoff: Stahl (ST)	Dicke	Werkstoff
NL	S-35x15-06-02-05-ST-00-00		0,5mm	DC01
NL	S-35x15-06-02-10-ST-00-00		1,0mm	DC01
NL	S-35x15-06-02-20-ST-00-00		2,0mm	DC01
NL	S-35x15-06-02-30-ST-00-00		3,0mm	DC01
NL	S-35x15-06-02-40-ST-00-00		4,0mm	DC01
NL	S-35x15-06-02-50-ST-00-00		5,0mm	DC01

L/NL	Bestellnummer	Werkstoff: Stahl (ST)	Dicke	Werkstoff
NL	SP-35x15-06-02-30-ST-00-00		3,0mm	DC01
bestehend aus: 1x 0,1/ 2x 0,2/ 3x 0,5/ 1x 1,0 mm				

L/NL	Bestellnummer	Werkstoff: Stahl (ST)	Dicke	Werkstoff
NL	SP-35x15-06-02-50-ST-00-00		5,0mm	DC01
bestehend aus: 1x 0,1/ 2x 0,2/ 3x 0,5/ 1x 1,0/ 1x 2,0 mm				

01.01 Shim-Abstimmplatten

Shimblech (S)
Shimpaket (SP)

32x12-06-03

L = lagernd

NL = nicht lagernd

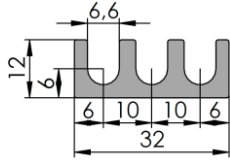

L/NL	Bestellnummer	Dicke	Werkstoff
	Shimblech (S) Werkstoff: Edelstahl (VA)		
NL	S-32x12-06-03-005-VA-00-00	0,05mm	1.4310
L	S-32x12-06-03-01-VA-00-00	0,1mm	1.4310
L	S-32x12-06-03-02-VA-00-00	0,2mm	1.4310
L	S-32x12-06-03-05-VA-00-00	0,5mm	1.4301
L	S-32x12-06-03-10-VA-00-00	1,0mm	1.4301
L	S-32x12-06-03-20-VA-00-00	2,0mm	1.4301
NL	S-32x12-06-03-30-VA-00-00	3,0mm	1.4301
NL	S-32x12-06-03-40-VA-00-00	4,0mm	1.4301
NL	S-32x12-06-03-50-VA-00-00	5,0mm	1.4301
	Shimpaket (SP) Werkstoff: Edelstahl (VA)		
L	SP-32x12-06-03-30-VA-00-00 bestehend aus: 1x 0,1/ 2x 0,2/ 3x 0,5/ 1x 1,0 mm	3,0mm	1.4301
L	SP-32x12-06-03-50-VA-00-00 bestehend aus: 1x 0,1/ 2x 0,2/ 3x 0,5/ 1x 1,0/ 1x 2,0 mm	5,0mm	1.4301
	Shimblech (S) Werkstoff: Stahl (ST)		
L	S-32x12-06-03-05-ST-00-00	0,5mm	DC01
L	S-32x12-06-03-10-ST-00-00	1,0mm	DC01
L	S-32x12-06-03-20-ST-00-00	2,0mm	DC01
L	S-32x12-06-03-30-ST-00-00	3,0mm	DC01
L	S-32x12-06-03-40-ST-00-00	4,0mm	DC01
L	S-32x12-06-03-50-ST-00-00	5,0mm	DC01
	Shimpaket (SP) Werkstoff: Stahl (ST)		
L	SP-32x12-06-03-30-ST-00-00 bestehend aus: 1x 0,1/ 2x 0,2/ 3x 0,5/ 1x 1,0 mm	3,0mm	DC01
L	SP-32x12-06-03-50-ST-00-00 bestehend aus: 1x 0,1/ 2x 0,2/ 3x 0,5/ 1x 1,0/ 1x 2,0 mm	5,0mm	DC01

01.01 Shim-Abstimmplatten

Shimblech (S)
Shimpaket (SP)

42x12-06-04

L = lagernd

NL = nicht lagernd

L/NL Bestellnummer

Dicke

Werkstoff

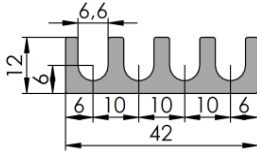

L/NL	Bestellnummer	Werkstoff: Edelstahl (VA)	Dicke	Werkstoff
NL	S-42x12-06-04-005-VA-00-00	Shimblech (S)	0,05mm	1.4310
L	S-42x12-06-04-01-VA-00-00		0,1mm	1.4310
L	S-42x12-06-04-02-VA-00-00		0,2mm	1.4310
L	S-42x12-06-04-05-VA-00-00		0,5mm	1.4301
L	S-42x12-06-04-10-VA-00-00		1,0mm	1.4301
L	S-42x12-06-04-20-VA-00-00		2,0mm	1.4301
NL	S-42x12-06-04-30-VA-00-00		3,0mm	1.4301
NL	S-42x12-06-04-40-VA-00-00		4,0mm	1.4301
NL	S-42x12-06-04-50-VA-00-00		5,0mm	1.4301

L	SP-42x12-06-04-30-VA-00-00	Shimpaket (SP) Werkstoff: Edelstahl (VA)	3,0mm	1.4301
bestehend aus: 1x 0,1/ 2x 0,2/ 3x 0,5/ 1x 1,0 mm				

L	SP-42x12-06-04-50-VA-00-00	Shimpaket (SP) Werkstoff: Edelstahl (VA)	5,0mm	1.4301
bestehend aus: 1x 0,1/ 2x 0,2/ 3x 0,5/ 1x 1,0/ 1x 2,0 mm				

L/NL	Bestellnummer	Werkstoff: Stahl (ST)	Dicke	Werkstoff
L	S-42x12-06-04-05-ST-00-00	Shimblech (S)	0,5mm	DC01
L	S-42x12-06-04-10-ST-00-00		1,0mm	DC01
L	S-42x12-06-04-20-ST-00-00		2,0mm	DC01
L	S-42x12-06-04-30-ST-00-00		3,0mm	DC01
L	S-42x12-06-04-40-ST-00-00		4,0mm	DC01
L	S-42x12-06-04-50-ST-00-00		5,0mm	DC01

L	SP-42x12-06-04-30-ST-00-00	Shimpaket (SP) Werkstoff: Stahl (ST)	3,0mm	DC01
bestehend aus: 1x 0,1/ 2x 0,2/ 3x 0,5/ 1x 1,0 mm				

L	SP-42x12-06-04-50-ST-00-00	Shimpaket (SP) Werkstoff: Stahl (ST)	5,0mm	DC01
bestehend aus: 1x 0,1/ 2x 0,2/ 3x 0,5/ 1x 1,0/ 1x 2,0 mm				

01.01 Shim-Abstimmplatten

Abmaße identisch
Audi / VW - Norm:
39D 20634/ 1 - 50

Shimblech (S)
Shimpaket (SP)

35x15-06-03

L = lagernd

NL = nicht lagernd

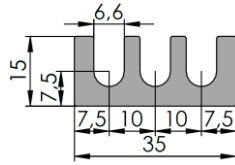

L/NL Bestellnummer

Dicke

Werkstoff

Shimblech (S)		Werkstoff: Edelstahl (VA)	
L	S-35x15-06-03-005-VA-00-00	0,05mm	1.4310
L	S-35x15-06-03-01-VA-00-00	0,1mm	1.4310
L	S-35x15-06-03-02-VA-00-00	0,2mm	1.4310
L	S-35x15-06-03-05-VA-00-00	0,5mm	1.4301
L	S-35x15-06-03-10-VA-00-00	1,0mm	1.4301
L	S-35x15-06-03-20-VA-00-00	2,0mm	1.4301
L	S-35x15-06-03-30-VA-00-00	3,0mm	1.4301
L	S-35x15-06-03-40-VA-00-00	4,0mm	1.4301
L	S-35x15-06-03-50-VA-00-00	5,0mm	1.4301

Shimpaket (SP)		Werkstoff: Edelstahl (VA)	
L	SP-35x15-06-03-30-VA-00-00	3,0mm	1.4301
bestehend aus: 1x 0,1/ 2x 0,2/ 3x 0,5/ 1x 1,0 mm			

Shimpaket (SP)		Werkstoff: Edelstahl (VA)	
L	SP-35x15-06-03-50-VA-00-00	5,0mm	1.4301
bestehend aus: 1x 0,1/ 2x 0,2/ 3x 0,5/ 1x 1,0/ 1x 2,0 mm			

Shimblech (S)		Werkstoff: Stahl (ST)	
L	S-35x15-06-03-05-ST-00-00	0,5mm	DC01
L	S-35x15-06-03-10-ST-00-00	1,0mm	DC01
L	S-35x15-06-03-20-ST-00-00	2,0mm	DC01
NL	S-35x15-06-03-30-ST-00-00	3,0mm	DC01
NL	S-35x15-06-03-40-ST-00-00	4,0mm	DC01
L	S-35x15-06-03-50-ST-00-00	5,0mm	DC01

Shimpaket (SP)		Werkstoff: Stahl (ST)	
L	SP-35x15-06-03-30-ST-00-00	3,0mm	DC01
bestehend aus: 1x 0,1/ 2x 0,2/ 3x 0,5/ 1x 1,0 mm			

Shimpaket (SP)		Werkstoff: Stahl (ST)	
L	SP-35x15-06-03-50-ST-00-00	5,0mm	DC01
bestehend aus: 1x 0,1/ 2x 0,2/ 3x 0,5/ 1x 1,0/ 1x 2,0 mm			

01.01 Shim-Abstimmplatten

Abmaße identisch
Audi / VW - Norm:
39D 20633/ 1 - 50

Shimblech (S)
Shimpaket (SP)

45x15-06-04

L = lagernd
NL = nicht lagernd

L/NL Bestellnummer

Dicke Werkstoff

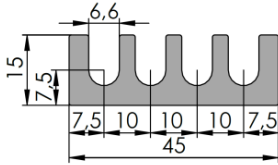

L/NL	Bestellnummer	Werkstoff: Edelstahl (VA)	Dicke	Werkstoff
NL	S-45x15-06-04-005-VA-00-00		0,05mm	1.4310
L	S-45x15-06-04-01-VA-00-00		0,1mm	1.4310
L	S-45x15-06-04-02-VA-00-00		0,2mm	1.4310
L	S-45x15-06-04-05-VA-00-00		0,5mm	1.4301
L	S-45x15-06-04-10-VA-00-00		1,0mm	1.4301
L	S-45x15-06-04-20-VA-00-00		2,0mm	1.4301
L	S-45x15-06-04-30-VA-00-00		3,0mm	1.4301
NL	S-45x15-06-04-40-VA-00-00		4,0mm	1.4301
L	S-45x15-06-04-50-VA-00-00		5,0mm	1.4301

L/NL	Bestellnummer	Werkstoff: Edelstahl (VA)	Dicke	Werkstoff
L	SP-45x15-06-04-30-VA-00-00		3,0mm	1.4301
bestehend aus: 1x 0,1/ 2x 0,2/ 3x 0,5/ 1x 1,0 mm				

L/NL	Bestellnummer	Werkstoff: Edelstahl (VA)	Dicke	Werkstoff
L	SP-45x15-06-04-50-VA-00-00		5,0mm	1.4301
bestehend aus: 1x 0,1/ 2x 0,2/ 3x 0,5/ 1x 1,0/ 1x 2,0 mm				

Shimblech (S) Werkstoff: **Stahl (ST)**

L	S-45x15-06-04-05-ST-00-00	0,5mm	DC01
L	S-45x15-06-04-10-ST-00-00	1,0mm	DC01
L	S-45x15-06-04-20-ST-00-00	2,0mm	DC01
L	S-45x15-06-04-30-ST-00-00	3,0mm	DC01
L	S-45x15-06-04-40-ST-00-00	4,0mm	DC01
L	S-45x15-06-04-50-ST-00-00	5,0mm	DC01

L/NL	Bestellnummer	Werkstoff: Stahl (ST)	Dicke	Werkstoff
L	SP-45x15-06-04-30-ST-00-00		3,0mm	DC01
bestehend aus: 1x 0,1/ 2x 0,2/ 3x 0,5/ 1x 1,0 mm				

L/NL	Bestellnummer	Werkstoff: Stahl (ST)	Dicke	Werkstoff
L	SP-45x15-06-04-50-ST-00-00		5,0mm	DC01
bestehend aus: 1x 0,1/ 2x 0,2/ 3x 0,5/ 1x 1,0/ 1x 2,0 mm				

01.01 Shim-Abstimmplatten

Shimblech (S)
Shimpaket (SP)

45x15-06-03

L = lagernd
NL = nicht lagernd

L/NL Bestellnummer

Dicke Werkstoff

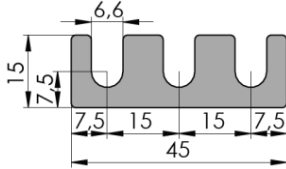

L/NL	Bestellnummer	Werkstoff: Edelstahl (VA)	Dicke	Werkstoff
NL	S -45x15-06-03- 005 -VA-00-00		0,05mm	1.4310
L	S -45x15-06-03- 01 -VA-00-00		0,1mm	1.4310
L	S -45x15-06-03- 02 -VA-00-00		0,2mm	1.4310
NL	S -45x15-06-03- 05 -VA-00-00		0,5mm	1.4301
NL	S -45x15-06-03- 10 -VA-00-00		1,0mm	1.4301
NL	S -45x15-06-03- 20 -VA-00-00		2,0mm	1.4301
NL	S -45x15-06-03- 30 -VA-00-00		3,0mm	1.4301
NL	S -45x15-06-03- 40 -VA-00-00		4,0mm	1.4301
NL	S -45x15-06-03- 50 -VA-00-00		5,0mm	1.4301

L/NL	Bestellnummer	Werkstoff: Edelstahl (VA)	Dicke	Werkstoff
NL	SP -45x15-06-03- 30 -VA-00-00		3,0mm	1.4301
bestehend aus: 1x 0,1/ 2x 0,2/ 3x 0,5/ 1x 1,0 mm				

L/NL	Bestellnummer	Werkstoff: Edelstahl (VA)	Dicke	Werkstoff
NL	SP -45x15-06-03- 50 -VA-00-00		5,0mm	1.4301
bestehend aus: 1x 0,1/ 2x 0,2/ 3x 0,5/ 1x 1,0/ 1x 2,0 mm				

L/NL	Bestellnummer	Werkstoff: Stahl (ST)	Dicke	Werkstoff
L	S -45x15-06-03- 05 -ST-00-00		0,5mm	DC01
L	S -45x15-06-03- 10 -ST-00-00		1,0mm	DC01
L	S -45x15-06-03- 20 -ST-00-00		2,0mm	DC01
NL	S -45x15-06-03- 30 -ST-00-00		3,0mm	DC01
NL	S -45x15-06-03- 40 -ST-00-00		4,0mm	DC01
NL	S -45x15-06-03- 50 -ST-00-00		5,0mm	DC01

L/NL	Bestellnummer	Werkstoff: Stahl (ST)	Dicke	Werkstoff
L	SP -45x15-06-03- 30 -ST-00-00		3,0mm	DC01
bestehend aus: 1x 0,1/ 2x 0,2/ 3x 0,5/ 1x 1,0 mm				

L/NL	Bestellnummer	Werkstoff: Stahl (ST)	Dicke	Werkstoff
L	SP -45x15-06-03- 50 -ST-00-00		5,0mm	DC01
bestehend aus: 1x 0,1/ 2x 0,2/ 3x 0,5/ 1x 1,0/ 1x 2,0 mm				

01.01 Shim-Abstimmplatten

Abmaße identisch
Audi / VW - Norm:
39D 20637/ 1 - 50

Shimblech (S)
Shimpaket (SP)

34x34-06-03

L = lagernd

NL = nicht lagernd

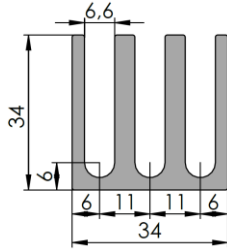

L/NL Bestellnummer

Dicke

Werkstoff

	Shimblech (S)	Werkstoff: Edelstahl (VA)		
NL	S -34x34-06-03- 005 -VA-00-00		0,05mm	1.4310
L	S -34x34-06-03- 01 -VA-00-00		0,1mm	1.4310
L	S -34x34-06-03- 02 -VA-00-00		0,2mm	1.4310
L	S -34x34-06-03- 05 -VA-00-00		0,5mm	1.4301
L	S -34x34-06-03- 10 -VA-00-00		1,0mm	1.4301
L	S -34x34-06-03- 20 -VA-00-00		2,0mm	1.4301
NL	S -34x34-06-03- 30 -VA-00-00		3,0mm	1.4301
NL	S -34x34-06-03- 40 -VA-00-00		4,0mm	1.4301
NL	S -34x34-06-03- 50 -VA-00-00		5,0mm	1.4301

	Shimpaket (SP)	Werkstoff: Edelstahl (VA)		
L	SP -34x34-06-03- 30 -VA-00-00		3,0mm	1.4301
bestehend aus: 1x 0,1/ 2x 0,2/ 3x 0,5/ 1x 1,0 mm				

	Shimpaket (SP)	Werkstoff: Edelstahl (VA)		
L	SP -34x34-06-03- 50 -VA-00-00		5,0mm	1.4301
bestehend aus: 1x 0,1/ 2x 0,2/ 3x 0,5/ 1x 1,0/ 1x 2,0 mm				

	Shimblech (S)	Werkstoff: Stahl (ST)		
NL	S -34x34-06-03- 05 -ST-00-00		0,5mm	DC01
NL	S -34x34-06-03- 10 -ST-00-00		1,0mm	DC01
NL	S -34x34-06-03- 20 -ST-00-00		2,0mm	DC01
NL	S -34x34-06-03- 30 -ST-00-00		3,0mm	DC01
NL	S -34x34-06-03- 40 -ST-00-00		4,0mm	DC01
NL	S -34x34-06-03- 50 -ST-00-00		5,0mm	DC01

	Shimpaket (SP)	Werkstoff: Stahl (ST)		
NL	SP -34x34-06-03- 30 -ST-00-00		3,0mm	DC01
bestehend aus: 1x 0,1/ 2x 0,2/ 3x 0,5/ 1x 1,0 mm				

	Shimpaket (SP)	Werkstoff: Stahl (ST)		
NL	SP -34x34-06-03- 50 -ST-00-00		5,0mm	DC01
bestehend aus: 1x 0,1/ 2x 0,2/ 3x 0,5/ 1x 1,0/ 1x 2,0 mm				

01.01 Shim-Abstimmplatten

Shimblech (S)
Shimpaket (SP)

20x20-08-01

L = lagernd

NL = nicht lagernd

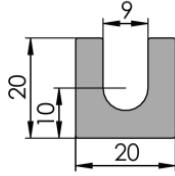

L/NL	Bestellnummer	Dicke	Werkstoff
	Shimblech (S) Werkstoff: Edelstahl (VA)		
L	S -20x20-08-01- 005 -VA-00-00	0,05mm	1.4310
L	S -20x20-08-01- 01 -VA-00-00	0,1mm	1.4310
L	S -20x20-08-01- 02 -VA-00-00	0,2mm	1.4310
L	S -20x20-08-01- 05 -VA-00-00	0,5mm	1.4301
L	S -20x20-08-01- 10 -VA-00-00	1,0mm	1.4301
L	S -20x20-08-01- 20 -VA-00-00	2,0mm	1.4301
L	S -20x20-08-01- 30 -VA-00-00	3,0mm	1.4301
L	S -20x20-08-01- 40 -VA-00-00	4,0mm	1.4301
L	S -20x20-08-01- 50 -VA-00-00	5,0mm	1.4301
	Shimpaket (SP) Werkstoff: Edelstahl (VA)		
L	SP -20x20-08-01- 30 -VA-00-00 bestehend aus: 1x 0,1/ 2x 0,2/ 3x 0,5/ 1x 1,0 mm	3,0mm	1.4301
L	Shimpaket (SP) Werkstoff: Edelstahl (VA) SP -20x20-08-01- 50 -VA-00-00 bestehend aus: 1x 0,1/ 2x 0,2/ 3x 0,5/ 1x 1,0/ 1x 2,0 mm	5,0mm	1.4301
	Shimblech (S) Werkstoff: Stahl (ST)		
L	S -20x20-08-01- 05 -ST-00-00	0,5mm	DC01
L	S -20x20-08-01- 10 -ST-00-00	1,0mm	DC01
L	S -20x20-08-01- 20 -ST-00-00	2,0mm	DC01
L	S -20x20-08-01- 30 -ST-00-00	3,0mm	DC01
L	S -20x20-08-01- 40 -ST-00-00	4,0mm	DC01
L	S -20x20-08-01- 50 -ST-00-00	5,0mm	DC01
	Shimpaket (SP) Werkstoff: Stahl (ST)		
L	SP -20x20-08-01- 30 -ST-00-00 bestehend aus: 1x 0,1/ 2x 0,2/ 3x 0,5/ 1x 1,0 mm	3,0mm	DC01
L	Shimpaket (SP) Werkstoff: Stahl (ST) SP -20x20-08-01- 50 -ST-00-00 bestehend aus: 1x 0,1/ 2x 0,2/ 3x 0,5/ 1x 1,0/ 1x 2,0 mm	5,0mm	DC01

01.01 Shim-Abstimmplatten

Shimblech (S)
Shimpaket (SP)

30x15-08-02

L = lagernd

NL = nicht lagernd

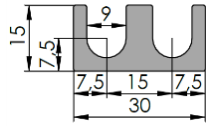

L/NL	Bestellnummer	Dicke	Werkstoff
	Shimblech (S) Werkstoff: Edelstahl (VA)		
L	S-30x15-08-02-005-VA-00-00	0,05mm	1.4310
L	S-30x15-08-02-01-VA-00-00	0,1mm	1.4310
L	S-30x15-08-02-02-VA-00-00	0,2mm	1.4310
L	S-30x15-08-02-05-VA-00-00	0,5mm	1.4301
L	S-30x15-08-02-10-VA-00-00	1,0mm	1.4301
L	S-30x15-08-02-20-VA-00-00	2,0mm	1.4301
NL	S-30x15-08-02-30-VA-00-00	3,0mm	1.4301
NL	S-30x15-08-02-40-VA-00-00	4,0mm	1.4301
L	S-30x15-08-02-50-VA-00-00	5,0mm	1.4301
	Shimpaket (SP) Werkstoff: Edelstahl (VA)		
L	SP-30x15-08-02-30-VA-00-00 bestehend aus: 1x 0,1/ 2x 0,2/ 3x 0,5/ 1x 1,0 mm	3,0mm	1.4301
L	SP-30x15-08-02-50-VA-00-00 bestehend aus: 1x 0,1/ 2x 0,2/ 3x 0,5/ 1x 1,0/ 1x 2,0 mm	5,0mm	1.4301
	Shimblech (S) Werkstoff: Stahl (ST)		
L	S-30x15-08-02-01-ST-00-00	0,1mm	DC01
L	S-30x15-08-02-05-ST-00-00	0,5mm	DC01
L	S-30x15-08-02-10-ST-00-00	1,0mm	DC01
L	S-30x15-08-02-20-ST-00-00	2,0mm	DC01
NL	S-30x15-08-02-30-ST-00-00	3,0mm	DC01
NL	S-30x15-08-02-40-ST-00-00	4,0mm	DC01
NL	S-30x15-08-02-50-ST-00-00	5,0mm	DC01
	Shimpaket (SP) Werkstoff: Stahl (ST)		
L	SP-30x15-08-02-30-ST-00-00 bestehend aus: 1x 0,1/ 2x 0,2/ 3x 0,5/ 1x 1,0 mm	3,0mm	DC01
L	SP-30x15-08-02-50-ST-00-00 bestehend aus: 1x 0,1/ 2x 0,2/ 3x 0,5/ 1x 1,0/ 1x 2,0 mm	5,0mm	DC01

01.01 Shim-Abstimmplatten

Shimblech (S)
Shimpaket (SP)

30x20-08-02

L = lagernd
NL = nicht lagernd

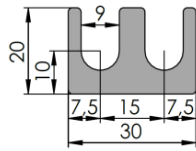

L/NL	Bestellnummer	Dicke	Werkstoff
Shimblech (S) Werkstoff: Edelstahl (VA)			
NL	S-30x20-08-02-005-VA-00-00	0,05mm	1.4310
NL	S-30x20-08-02-01-VA-00-00	0,1mm	1.4310
L	S-30x20-08-02-02-VA-00-00	0,2mm	1.4310
NL	S-30x20-08-02-05-VA-00-00	0,5mm	1.4301
NL	S-30x20-08-02-10-VA-00-00	1,0mm	1.4301
NL	S-30x20-08-02-20-VA-00-00	2,0mm	1.4301
NL	S-30x20-08-02-30-VA-00-00	3,0mm	1.4301
NL	S-30x20-08-02-40-VA-00-00	4,0mm	1.4301
NL	S-30x20-08-02-50-VA-00-00	5,0mm	1.4301
Shimpaket (SP) Werkstoff: Edelstahl (VA)			
NL	SP-30x20-08-02-30-VA-00-00	3,0mm	1.4301
	bestehend aus: 1x 0,1/ 2x 0,2/ 3x 0,5/ 1x 1,0 mm		
NL	SP-30x20-08-02-50-VA-00-00	5,0mm	1.4301
	bestehend aus: 1x 0,1/ 2x 0,2/ 3x 0,5/ 1x 1,0/ 1x 2,0 mm		
<hr/>			
Shimblech (S) Werkstoff: Stahl (ST)			
L	S-30x20-08-02-01-ST-00-00	0,1mm	DC01
L	S-30x20-08-02-05-ST-00-00	0,5mm	DC01
L	S-30x20-08-02-10-ST-00-00	1,0mm	DC01
L	S-30x20-08-02-20-ST-00-00	2,0mm	DC01
L	S-30x20-08-02-30-ST-00-00	3,0mm	DC01
L	S-30x20-08-02-40-ST-00-00	4,0mm	DC01
NL	S-30x20-08-02-50-ST-00-00	5,0mm	DC01
Shimpaket (SP) Werkstoff: Stahl (ST)			
L	SP-30x20-08-02-30-ST-00-00	3,0mm	DC01
	bestehend aus: 1x 0,1/ 2x 0,2/ 3x 0,5/ 1x 1,0 mm		
L	SP-30x20-08-02-50-ST-00-00	5,0mm	DC01
	bestehend aus: 1x 0,1/ 2x 0,2/ 3x 0,5/ 1x 1,0/ 1x 2,0 mm		

01.01 Shim-Abstimmplatten

Shimblech (S)
Shimpaket (SP)

45x15-08-03

L = lagernd

NL = nicht lagernd

L/NL Bestellnummer

Dicke

Werkstoff

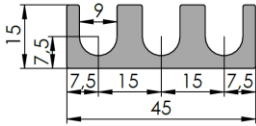

L/NL	Bestellnummer	Dicke	Werkstoff
	Shimblech (S) Werkstoff: Edelstahl (VA)		
NL	S-45x15-08-03-005-VA-00-00	0,05mm	1.4310
NL	S-45x15-08-03-01-VA-00-00	0,1mm	1.4310
L	S-45x15-08-03-02-VA-00-00	0,2mm	1.4310
NL	S-45x15-08-03-05-VA-00-00	0,5mm	1.4301
NL	S-45x15-08-03-10-VA-00-00	1,0mm	1.4301
NL	S-45x15-08-03-20-VA-00-00	2,0mm	1.4301
NL	S-45x15-08-03-30-VA-00-00	3,0mm	1.4301
NL	S-45x15-08-03-40-VA-00-00	4,0mm	1.4301
NL	S-45x15-08-03-50-VA-00-00	5,0mm	1.4301

	Shimpaket (SP) Werkstoff: Edelstahl (VA)		
NL	SP-45x15-08-03-30-VA-00-00	3,0mm	1.4301
	bestehend aus: 1x 0,1/ 2x 0,2/ 3x 0,5/ 1x 1,0 mm		

	Shimpaket (SP) Werkstoff: Edelstahl (VA)		
NL	SP-45x15-08-03-50-VA-00-00	5,0mm	1.4301
	bestehend aus: 1x 0,1/ 2x 0,2/ 3x 0,5/ 1x 1,0/ 1x 2,0 mm		

	Shimblech (S) Werkstoff: Stahl (ST)		
L	S-45x15-08-03-01-ST-00-00	0,1mm	DC01
L	S-45x15-08-03-05-ST-00-00	0,5mm	DC01
L	S-45x15-08-03-10-ST-00-00	1,0mm	DC01
L	S-45x15-08-03-20-ST-00-00	2,0mm	DC01
NL	S-45x15-08-03-30-ST-00-00	3,0mm	DC01
NL	S-45x15-08-03-40-ST-00-00	4,0mm	DC01
NL	S-45x15-08-03-50-ST-00-00	5,0mm	DC01

	Shimpaket (SP) Werkstoff: Stahl (ST)		
L	SP-45x15-08-03-30-ST-00-00	3,0mm	DC01
	bestehend aus: 1x 0,1/ 2x 0,2/ 3x 0,5/ 1x 1,0 mm		

	Shimpaket (SP) Werkstoff: Stahl (ST)		
L	SP-45x15-08-03-50-ST-00-00	5,0mm	DC01
	bestehend aus: 1x 0,1/ 2x 0,2/ 3x 0,5/ 1x 1,0/ 1x 2,0 mm		

01.01 Shim-Abstimmplatten

Shimblech (S)
Shimpaket (SP)

45x20-08-03

L = lagernd

NL = nicht lagernd

L/NL Bestellnummer

Dicke

Werkstoff

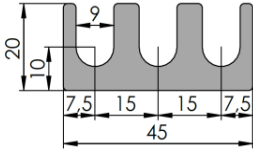

Shimblech (S) Werkstoff: Edelstahl (VA)			
L	S-45x20-08-03-005-VA-00-00	0,05mm	1.4310
L	S-45x20-08-03-01-VA-00-00	0,1mm	1.4310
L	S-45x20-08-03-02-VA-00-00	0,2mm	1.4310
L	S-45x20-08-03-05-VA-00-00	0,5mm	1.4301
L	S-45x20-08-03-10-VA-00-00	1,0mm	1.4301
L	S-45x20-08-03-20-VA-00-00	2,0mm	1.4301
L	S-45x20-08-03-30-VA-00-00	3,0mm	1.4301
L	S-45x20-08-03-40-VA-00-00	4,0mm	1.4301
L	S-45x20-08-03-50-VA-00-00	5,0mm	1.4301

Shimpaket (SP) Werkstoff: Edelstahl (VA)			
L	SP-45x20-08-03-30-VA-00-00 bestehend aus: 1x 0,1/ 2x 0,2/ 3x 0,5/ 1x 1,0 mm	3,0mm	1.4301

Shimpaket (SP) Werkstoff: Edelstahl (VA)			
L	SP-45x20-08-03-50-VA-00-00 bestehend aus: 1x 0,1/ 2x 0,2/ 3x 0,5/ 1x 1,0/ 1x 2,0 mm	5,0mm	1.4301

Shimblech (S) Werkstoff: Stahl (ST)			
L	S-45x20-08-03-05-ST-00-00	0,5mm	DC01
L	S-45x20-08-03-10-ST-00-00	1,0mm	DC01
L	S-45x20-08-03-20-ST-00-00	2,0mm	DC01
NL	S-45x20-08-03-30-ST-00-00	3,0mm	DC01
NL	S-45x20-08-03-40-ST-00-00	4,0mm	DC01
L	S-45x20-08-03-50-ST-00-00	5,0mm	DC01

Shimpaket (SP) Werkstoff: Stahl (ST)			
L	SP-45x20-08-03-30-ST-00-00 bestehend aus: 1x 0,1/ 2x 0,2/ 3x 0,5/ 1x 1,0 mm	3,0mm	DC01

Shimpaket (SP) Werkstoff: Stahl (ST)			
L	SP-45x20-08-03-50-ST-00-00 bestehend aus: 1x 0,1/ 2x 0,2/ 3x 0,5/ 1x 1,0/ 1x 2,0 mm	5,0mm	DC01

01.01 Shim-Abstimmplatten

Abmaße identisch
Audi / VW - Norm:
39D 20632/ 1 - 50

Shimblech (S)
Shimpaket (SP)

50x20-08-03

L = lagernd

NL = nicht lagernd

L/NL Bestellnummer

Dicke

Werkstoff

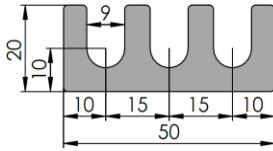

L/NL	Bestellnummer	Dicke	Werkstoff
	Shimblech (S) Werkstoff: Edelstahl (VA)		
L	S-50x20-08-03-005-VA-00-00	0,05mm	1.4310
L	S-50x20-08-03-01-VA-00-00	0,1mm	1.4310
L	S-50x20-08-03-02-VA-00-00	0,2mm	1.4310
L	S-50x20-08-03-05-VA-00-00	0,5mm	1.4301
L	S-50x20-08-03-10-VA-00-00	1,0mm	1.4301
L	S-50x20-08-03-20-VA-00-00	2,0mm	1.4301
L	S-50x20-08-03-30-VA-00-00	3,0mm	1.4301
NL	S-50x20-08-03-40-VA-00-00	4,0mm	1.4301
L	S-50x20-08-03-50-VA-00-00	5,0mm	1.4301

	Shimpaket (SP) Werkstoff: Edelstahl (VA)		
L	SP-50x20-08-03-30-VA-00-00	3,0mm	1.4301
	bestehend aus: 1x 0,1/ 2x 0,2/ 3x 0,5/ 1x 1,0 mm		

	Shimpaket (SP) Werkstoff: Edelstahl (VA)		
L	SP-50x20-08-03-50-VA-00-00	5,0mm	1.4301
	bestehend aus: 1x 0,1/ 2x 0,2/ 3x 0,5/ 1x 1,0/ 1x 2,0 mm		

L/NL	Bestellnummer	Dicke	Werkstoff
	Shimblech (S) Werkstoff: Stahl (ST)		
L	S-50x20-08-03-05-ST-00-00	0,5mm	DC01
L	S-50x20-08-03-10-ST-00-00	1,0mm	DC01
L	S-50x20-08-03-20-ST-00-00	2,0mm	DC01
L	S-50x20-08-03-30-ST-00-00	3,0mm	DC01
L	S-50x20-08-03-40-ST-00-00	4,0mm	DC01
L	S-50x20-08-03-50-ST-00-00	5,0mm	DC01

	Shimpaket (SP) Werkstoff: Stahl (ST)		
L	SP-50x20-08-03-30-ST-00-00	3,0mm	DC01
	bestehend aus: 1x 0,1/ 2x 0,2/ 3x 0,5/ 1x 1,0 mm		

	Shimpaket (SP) Werkstoff: Stahl (ST)		
L	SP-50x20-08-03-50-ST-00-00	5,0mm	DC01
	bestehend aus: 1x 0,1/ 2x 0,2/ 3x 0,5/ 1x 1,0/ 1x 2,0 mm		



01.01 Shim-Abstimmplatten

Abmaße identisch
Audi / VW - Norm:
39D 20632/ 1 - 50

Shimblech (S)
Shimpaket (SP)

60x20-08-04

L = lagernd
NL = nicht lagernd

L/NL Bestellnummer **Dicke** **Werkstoff**

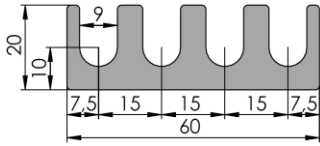

	Shimblech (S)	Werkstoff: Edelstahl (VA)		
L	S-60x20-08-04-005-VA-00-00		0,05mm	1.4310
L	S-60x20-08-04-01-VA-00-00		0,1mm	1.4310
L	S-60x20-08-04-02-VA-00-00		0,2mm	1.4310
L	S-60x20-08-04-05-VA-00-00		0,5mm	1.4301
L	S-60x20-08-04-10-VA-00-00		1,0mm	1.4301
L	S-60x20-08-04-20-VA-00-00		2,0mm	1.4301
NL	S-60x20-08-04-30-VA-00-00		3,0mm	1.4301
NL	S-60x20-08-04-40-VA-00-00		4,0mm	1.4301
L	S-60x20-08-04-50-VA-00-00		5,0mm	1.4301

	Shimpaket (SP)	Werkstoff: Edelstahl (VA)		
L	SP-60x20-08-04-30-VA-00-00		3,0mm	1.4301
	bestehend aus: 1x 0,1/ 2x 0,2/ 3x 0,5/ 1x 1,0 mm			

	Shimpaket (SP)	Werkstoff: Edelstahl (VA)		
L	SP-60x20-08-04-50-VA-00-00		5,0mm	1.4301
	bestehend aus: 1x 0,1/ 2x 0,2/ 3x 0,5/ 1x 1,0/ 1x 2,0 mm			

	Shimblech (S)	Werkstoff: Stahl (ST)		
L	S-60x20-08-04-05-ST-00-00		0,5mm	DC01
L	S-60x20-08-04-10-ST-00-00		1,0mm	DC01
L	S-60x20-08-04-20-ST-00-00		2,0mm	DC01
NL	S-60x20-08-04-30-ST-00-00		3,0mm	DC01
NL	S-60x20-08-04-40-ST-00-00		4,0mm	DC01
NL	S-60x20-08-04-50-ST-00-00		5,0mm	DC01

	Shimpaket (SP)	Werkstoff: Stahl (ST)		
L	SP-60x20-08-04-30-ST-00-00		3,0mm	DC01
	bestehend aus: 1x 0,1/ 2x 0,2/ 3x 0,5/ 1x 1,0 mm			

	Shimpaket (SP)	Werkstoff: Stahl (ST)		
L	SP-60x20-08-04-50-ST-00-00		5,0mm	DC01
	bestehend aus: 1x 0,1/ 2x 0,2/ 3x 0,5/ 1x 1,0/ 1x 2,0 mm			

01.01 Shim-Abstimmplatten

Shimblech (S)
Shimpaket (SP)

65x15-08-04

L = lagernd
NL = nicht lagernd

L/NL Bestellnummer

Dicke Werkstoff

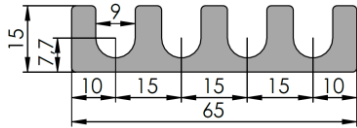

L/NL	Bestellnummer	Dicke	Werkstoff
Shimblech (S) Werkstoff: Edelstahl (VA)			
NL	S-65x15-08-04-005-VA-00-00	0,05mm	1.4310
L	S-65x15-08-04-01-VA-00-00	0,1mm	1.4310
L	S-65x15-08-04-02-VA-00-00	0,2mm	1.4310
L	S-65x15-08-04-05-VA-00-00	0,5mm	1.4301
L	S-65x15-08-04-10-VA-00-00	1,0mm	1.4301
L	S-65x15-08-04-20-VA-00-00	2,0mm	1.4301
NL	S-65x15-08-04-30-VA-00-00	3,0mm	1.4301
NL	S-65x15-08-04-40-VA-00-00	4,0mm	1.4301
NL	S-65x15-08-04-50-VA-00-00	5,0mm	1.4301

Shimpaket (SP) Werkstoff: Edelstahl (VA)			
L	SP-65x15-08-04-30-VA-00-00	3,0mm	1.4301
bestehend aus: 1x 0,1/ 2x 0,2/ 3x 0,5/ 1x 1,0 mm			

Shimpaket (SP) Werkstoff: Edelstahl (VA)			
L	SP-65x15-08-04-50-VA-00-00	5,0mm	1.4301
bestehend aus: 1x 0,1/ 2x 0,2/ 3x 0,5/ 1x 1,0/ 1x 2,0 mm			

L/NL	Bestellnummer	Dicke	Werkstoff
Shimblech (S) Werkstoff: Stahl (ST)			
L	S-65x15-08-04-05-ST-00-00	0,5mm	DC01
L	S-65x15-08-04-10-ST-00-00	1,0mm	DC01
L	S-65x15-08-04-20-ST-00-00	2,0mm	DC01
NL	S-65x15-08-04-30-ST-00-00	3,0mm	DC01
NL	S-65x15-08-04-40-ST-00-00	4,0mm	DC01
NL	S-65x15-08-04-50-ST-00-00	5,0mm	DC01

Shimpaket (SP) Werkstoff: Stahl (ST)			
L	SP-65x15-08-04-30-ST-00-00	3,0mm	DC01
bestehend aus: 1x 0,1/ 2x 0,2/ 3x 0,5/ 1x 1,0 mm			

Shimpaket (SP) Werkstoff: Stahl (ST)			
L	SP-65x15-08-04-50-ST-00-00	5,0mm	DC01
bestehend aus: 1x 0,1/ 2x 0,2/ 3x 0,5/ 1x 1,0/ 1x 2,0 mm			

01.01 Shim-Abstimmplatten

Abmaße identisch
Audi / VW - Norm:
39D 20631/ 1 - 50

Shimblech (S)
Shimpaket (SP)

65x20-08-04

L = lagernd
NL = nicht lagernd

L/NL Bestellnummer

Dicke Werkstoff

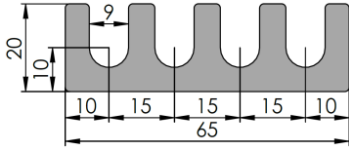

Shimblech (S)		Werkstoff: Edelstahl (VA)	
L	S-65x20-08-04-005-VA-00-00	0,05mm	1.4310
L	S-65x20-08-04-01-VA-00-00	0,1mm	1.4310
L	S-65x20-08-04-02-VA-00-00	0,2mm	1.4310
L	S-65x20-08-04-05-VA-00-00	0,5mm	1.4301
L	S-65x20-08-04-10-VA-00-00	1,0mm	1.4301
L	S-65x20-08-04-20-VA-00-00	2,0mm	1.4301
L	S-65x20-08-04-30-VA-00-00	3,0mm	1.4301
NL	S-65x20-08-04-40-VA-00-00	4,0mm	1.4301
NL	S-65x20-08-04-50-VA-00-00	5,0mm	1.4301

Shimpaket (SP)		Werkstoff: Edelstahl (VA)	
L	SP-65x20-08-04-30-VA-00-00	3,0mm	1.4301
bestehend aus: 1x 0,1/ 2x 0,2/ 3x 0,5/ 1x 1,0 mm			

Shimpaket (SP)		Werkstoff: Edelstahl (VA)	
L	SP-65x20-08-04-50-VA-00-00	5,0mm	1.4301
bestehend aus: 1x 0,1/ 2x 0,2/ 3x 0,5/ 1x 1,0/ 1x 2,0 mm			

Shimblech (S) Werkstoff: **Stahl (ST)**

L	S-65x20-08-04-05-ST-00-00	0,5mm	DC01
L	S-65x20-08-04-10-ST-00-00	1,0mm	DC01
L	S-65x20-08-04-20-ST-00-00	2,0mm	DC01
L	S-65x20-08-04-30-ST-00-00	3,0mm	DC01
L	S-65x20-08-04-40-ST-00-00	4,0mm	DC01
L	S-65x20-08-04-50-ST-00-00	5,0mm	DC01

Shimpaket (SP)		Werkstoff: Stahl (ST)	
L	SP-65x20-08-04-30-ST-00-00	3,0mm	DC01
bestehend aus: 1x 0,1/ 2x 0,2/ 3x 0,5/ 1x 1,0 mm			

Shimpaket (SP)		Werkstoff: Stahl (ST)	
L	SP-65x20-08-04-50-ST-00-00	5,0mm	DC01
bestehend aus: 1x 0,1/ 2x 0,2/ 3x 0,5/ 1x 1,0/ 1x 2,0 mm			



01.01 Shim-Abstimmplatten

Abmaße identisch
Audi / VW - Norm:
39D 20635/ 1 - 50

Shimblech (S)
Shimpaket (SP)

50x50-08-03

L = lagernd
NL = nicht lagernd

L/NL Bestellnummer **Dicke** **Werkstoff**

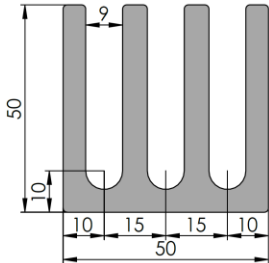

	Shimblech (S)	Werkstoff: Edelstahl (VA)		
L	S-50x50-08-03-005-VA-00-00		0,05mm	1.4310
L	S-50x50-08-03-01-VA-00-00		0,1mm	1.4310
L	S-50x50-08-03-02-VA-00-00		0,2mm	1.4310
L	S-50x50-08-03-05-VA-00-00		0,5mm	1.4301
L	S-50x50-08-03-10-VA-00-00		1,0mm	1.4301
L	S-50x50-08-03-20-VA-00-00		2,0mm	1.4301
L	S-50x50-08-03-30-VA-00-00		3,0mm	1.4301
NL	S-50x50-08-03-40-VA-00-00		4,0mm	1.4301
L	S-50x50-08-03-50-VA-00-00		5,0mm	1.4301

	Shimpaket (SP)	Werkstoff: Edelstahl (VA)		
L	SP-50x50-08-03-30-VA-00-00		3,0mm	1.4301
	bestehend aus: 1x 0,1/ 2x 0,2/ 3x 0,5/ 1x 1,0 mm			

	Shimpaket (SP)	Werkstoff: Edelstahl (VA)		
L	SP-50x50-08-03-50-VA-00-00		5,0mm	1.4301
	bestehend aus: 1x 0,1/ 2x 0,2/ 3x 0,5/ 1x 1,0/ 1x 2,0 mm			

	Shimblech (S)	Werkstoff: Stahl (ST)		
L	S-50x50-08-03-05-ST-00-00		0,5mm	DC01
L	S-50x50-08-03-10-ST-00-00		1,0mm	DC01
L	S-50x50-08-03-20-ST-00-00		2,0mm	DC01
L	S-50x50-08-03-30-ST-00-00		3,0mm	DC01
L	S-50x50-08-03-40-ST-00-00		4,0mm	DC01
L	S-50x50-08-03-50-ST-00-00		5,0mm	DC01

	Shimpaket (SP)	Werkstoff: Stahl (ST)		
L	SP-50x50-08-03-30-ST-00-00		3,0mm	DC01
	bestehend aus: 1x 0,1/ 2x 0,2/ 3x 0,5/ 1x 1,0 mm			

	Shimpaket (SP)	Werkstoff: Stahl (ST)		
L	SP-50x50-08-03-50-ST-00-00		5,0mm	DC01
	bestehend aus: 1x 0,1/ 2x 0,2/ 3x 0,5/ 1x 1,0/ 1x 2,0 mm			



01.01 Shim-Abstimmplatten

Abmaße identisch
Audi / VW - Norm:

Shimblech (S)
Shimpaket (SP)

70x70-08-02

11 - 38D 578 496/ 1-7

L = lagernd
NL = nicht lagernd

L/NL Bestellnummer

Dicke Werkstoff

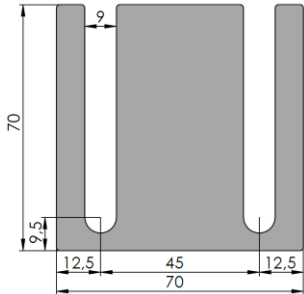

L/NL	Bestellnummer	Werkstoff: Edelstahl (VA)	Dicke	Werkstoff
NL	S-70x70-08-02-005-VA-00-00		0,05mm	1.4310
L	S-70x70-08-02-01-VA-00-00		0,1mm	1.4310
L	S-70x70-08-02-02-VA-00-00		0,2mm	1.4310
L	S-70x70-08-02-05-VA-00-00		0,5mm	1.4301
L	S-70x70-08-02-10-VA-00-00		1,0mm	1.4301
L	S-70x70-08-02-20-VA-00-00		2,0mm	1.4301
NL	S-70x70-08-02-30-VA-00-00		3,0mm	1.4301
NL	S-70x70-08-02-40-VA-00-00		4,0mm	1.4301
NL	S-70x70-08-02-50-VA-00-00		5,0mm	1.4301

L/NL	Bestellnummer	Werkstoff: Edelstahl (VA)	Dicke	Werkstoff
L	SP-70x70-08-02-30-VA-00-00		3,0mm	1.4301
bestehend aus: 1x 0,1/ 2x 0,2/ 3x 0,5/ 1x 1,0 mm				

L/NL	Bestellnummer	Werkstoff: Edelstahl (VA)	Dicke	Werkstoff
L	SP-70x70-08-02-50-VA-00-00		5,0mm	1.4301
bestehend aus: 1x 0,1/ 2x 0,2/ 3x 0,5/ 1x 1,0/ 1x 2,0 mm				

L/NL	Bestellnummer	Werkstoff: Stahl (ST)	Dicke	Werkstoff
NL	S-70x70-08-02-05-ST-00-00		0,5mm	DC01
NL	S-70x70-08-02-10-ST-00-00		1,0mm	DC01
NL	S-70x70-08-02-20-ST-00-00		2,0mm	DC01
NL	S-70x70-08-02-30-ST-00-00		3,0mm	DC01
NL	S-70x70-08-02-40-ST-00-00		4,0mm	DC01
NL	S-70x70-08-02-50-ST-00-00		5,0mm	DC01

L/NL	Bestellnummer	Werkstoff: Stahl (ST)	Dicke	Werkstoff
NL	SP-70x70-08-02-30-ST-00-00		3,0mm	DC01
bestehend aus: 1x 0,1/ 2x 0,2/ 3x 0,5/ 1x 1,0 mm				

L/NL	Bestellnummer	Werkstoff: Stahl (ST)	Dicke	Werkstoff
NL	SP-70x70-08-02-50-ST-00-00		5,0mm	DC01
bestehend aus: 1x 0,1/ 2x 0,2/ 3x 0,5/ 1x 1,0/ 1x 2,0 mm				

01.01 Shim-Abstimmplatten

Shim m. Durchgang (SD)
ShimDurchgangpaket (SDP)

34x16-06-03

L = lagernd

NL = nicht lagernd

L/NL	Bestellnummer	Dicke	Werkstoff
	Shimblech (SD) Werkstoff: Edelstahl (VA)		
NL	SD-34x16-06-03-005-VA-00-00	0,05mm	1.4310
NL	SD-34x16-06-03-01-VA-00-00	0,1mm	1.4310
NL	SD-34x16-06-03-02-VA-00-00	0,2mm	1.4310
NL	SD-34x16-06-03-05-VA-00-00	0,5mm	1.4301
NL	SD-34x16-06-03-10-VA-00-00	1,0mm	1.4301
NL	SD-34x16-06-03-20-VA-00-00	2,0mm	1.4301
NL	SD-34x16-06-03-30-VA-00-00	3,0mm	1.4301
NL	SD-34x16-06-03-40-VA-00-00	4,0mm	1.4301
NL	SD-34x16-06-03-50-VA-00-00	5,0mm	1.4301

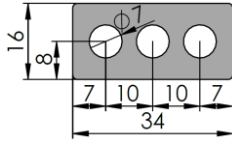

	Shimpaket (SDP) Werkstoff: Edelstahl (VA)		
NL	SDP-34x16-06-03-30-VA-00-00 bestehend aus: 1x 0,1/ 2x 0,2/ 3x 0,5/ 1x 1,0 mm	3,0mm	1.4301

	Shimpaket (SDP) Werkstoff: Edelstahl (VA)		
NL	SDP-34x16-06-03-50-VA-00-00 bestehend aus: 1x 0,1/ 2x 0,2/ 3x 0,5/ 1x 1,0/ 1x 2,0 mm	5,0mm	1.4301

Shimblech (S) Werkstoff: **Stahl (ST)**

NL	SD-34x16-06-03-05-ST-00-00	0,5mm	DC01
NL	SD-34x16-06-03-10-ST-00-00	1,0mm	DC01
NL	SD-34x16-06-03-20-ST-00-00	2,0mm	DC01
NL	SD-34x16-06-03-30-ST-00-00	3,0mm	DC01
NL	SD-34x16-06-03-40-ST-00-00	4,0mm	DC01
L	SD-34x16-06-03-50-ST-00-00	5,0mm	DC01

	Shimpaket (SDP) Werkstoff: Stahl (ST)		
NL	SDP-34x16-06-03-30-ST-00-00 bestehend aus: 1x 0,1/ 2x 0,2/ 3x 0,5/ 1x 1,0 mm	3,0mm	DC01

	Shimpaket (SDP) Werkstoff: Stahl (ST)		
NL	SDP-34x16-06-03-50-ST-00-00 bestehend aus: 1x 0,1/ 2x 0,2/ 3x 0,5/ 1x 1,0/ 1x 2,0 mm	5,0mm	DC01

01.01 Shim-Abstimmplatten

Shim m. Durchgang (SD)
ShimDurchgangpaket (SDP)

35x16-06-03

L = lagernd

NL = nicht lagernd

L/NL	Bestellnummer	Dicke	Werkstoff
	Shimblech (SD) Werkstoff: Edelstahl (VA)		
NL	SD-35x16-06-03-005-VA-00-00	0,05mm	1.4310
NL	SD-35x16-06-03-01-VA-00-00	0,1mm	1.4310
NL	SD-35x16-06-03-02-VA-00-00	0,2mm	1.4310
NL	SD-35x16-06-03-05-VA-00-00	0,5mm	1.4301
NL	SD-35x16-06-03-10-VA-00-00	1,0mm	1.4301
NL	SD-35x16-06-03-20-VA-00-00	2,0mm	1.4301
NL	SD-35x16-06-03-30-VA-00-00	3,0mm	1.4301
NL	SD-35x16-06-03-40-VA-00-00	4,0mm	1.4301
NL	SD-35x16-06-03-50-VA-00-00	5,0mm	1.4301

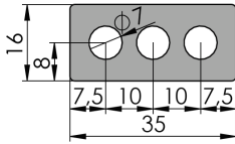

	Shimpaket (SDP) Werkstoff: Edelstahl (VA)		
NL	SDP-35x16-06-03-30-VA-00-00 bestehend aus: 1x 0,1/ 2x 0,2/ 3x 0,5/ 1x 1,0 mm	3,0mm	1.4301

	Shimpaket (SDP) Werkstoff: Edelstahl (VA)		
NL	SDP-35x16-06-03-50-VA-00-00 bestehend aus: 1x 0,1/ 2x 0,2/ 3x 0,5/ 1x 1,0/ 1x 2,0 mm	5,0mm	1.4301

Shimblech (S) Werkstoff: **Stahl (ST)**

NL	SD-35x16-06-03-05-ST-00-00	0,5mm	DC01
NL	SD-35x16-06-03-10-ST-00-00	1,0mm	DC01
NL	SD-35x16-06-03-20-ST-00-00	2,0mm	DC01
NL	SD-35x16-06-03-30-ST-00-00	3,0mm	DC01
NL	SD-35x16-06-03-40-ST-00-00	4,0mm	DC01
L	SD-35x16-06-03-50-ST-00-00	5,0mm	DC01

	Shimpaket (SDP) Werkstoff: Stahl (ST)		
NL	SDP-35x16-06-03-30-ST-00-00 bestehend aus: 1x 0,1/ 2x 0,2/ 3x 0,5/ 1x 1,0 mm	3,0mm	DC01

	Shimpaket (SDP) Werkstoff: Stahl (ST)		
NL	SDP-35x16-06-03-50-ST-00-00 bestehend aus: 1x 0,1/ 2x 0,2/ 3x 0,5/ 1x 1,0/ 1x 2,0 mm	5,0mm	DC01

01.01 Shim-Abstimmplatten

Shim m. Durchgang (SD)
ShimDurchgangpaket (SDP)

45x15-08-03

L = lagernd

NL = nicht lagernd

L/NL Bestellnummer

Dicke

Werkstoff

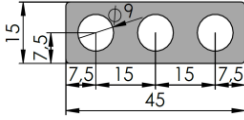

Shimblech (SD) Werkstoff: **Edelstahl (VA)**

NL	SD-45x15-08-03-005-VA-00-00	0,05mm	1.4310
NL	SD-45x15-08-03-01-VA-00-00	0,1mm	1.4310
NL	SD-45x15-08-03-02-VA-00-00	0,2mm	1.4310
NL	SD-45x15-08-03-05-VA-00-00	0,5mm	1.4301
NL	SD-45x15-08-03-10-VA-00-00	1,0mm	1.4301
NL	SD-45x15-08-03-20-VA-00-00	2,0mm	1.4301
NL	SD-45x15-08-03-30-VA-00-00	3,0mm	1.4301
NL	SD-45x15-08-03-40-VA-00-00	4,0mm	1.4301
NL	SD-45x15-08-03-50-VA-00-00	5,0mm	1.4301

Shimpaket (SDP) Werkstoff: **Edelstahl (VA)**

NL	SDP-45x15-08-03-30-VA-00-00	3,0mm	1.4301
bestehend aus: 1x 0,1/ 2x 0,2/ 3x 0,5/ 1x 1,0 mm			

Shimpaket (SDP) Werkstoff: **Edelstahl (VA)**

NL	SDP-45x15-08-03-50-VA-00-00	5,0mm	1.4301
bestehend aus: 1x 0,1/ 2x 0,2/ 3x 0,5/ 1x 1,0/ 1x 2,0 mm			

Shimblech (S) Werkstoff: **Stahl (ST)**

NL	SD-45x15-08-03-05-ST-00-00	0,5mm	DC01
NL	SD-45x15-08-03-10-ST-00-00	1,0mm	DC01
NL	SD-45x15-08-03-20-ST-00-00	2,0mm	DC01
NL	SD-45x15-08-03-30-ST-00-00	3,0mm	DC01
NL	SD-45x15-08-03-40-ST-00-00	4,0mm	DC01
L	SD-45x15-08-03-50-ST-00-00	5,0mm	DC01

Shimpaket (SDP) Werkstoff: **Stahl (ST)**

NL	SDP-45x15-08-03-30-ST-00-00	3,0mm	DC01
bestehend aus: 1x 0,1/ 2x 0,2/ 3x 0,5/ 1x 1,0 mm			

Shimpaket (SDP) Werkstoff: **Stahl (ST)**

NL	SDP-45x15-08-03-50-ST-00-00	5,0mm	DC01
bestehend aus: 1x 0,1/ 2x 0,2/ 3x 0,5/ 1x 1,0/ 1x 2,0 mm			

01.01 Shim-Abstimmplatten

Shim m. Durchgang (SD)
ShimDurchgangpaket (SDP)

46x20-08-03

L = lagernd

NL = nicht lagernd

L/NL Bestellnummer

Dicke

Werkstoff

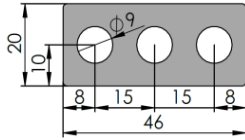

Shimblech (SD) Werkstoff: **Edelstahl (VA)**

NL	SD-46x20-08-03-005-VA-00-00	0,05mm	1.4310
NL	SD-46x20-08-03-01-VA-00-00	0,1mm	1.4310
NL	SD-46x20-08-03-02-VA-00-00	0,2mm	1.4310
NL	SD-46x20-08-03-05-VA-00-00	0,5mm	1.4301
NL	SD-46x20-08-03-10-VA-00-00	1,0mm	1.4301
NL	SD-46x20-08-03-20-VA-00-00	2,0mm	1.4301
NL	SD-46x20-08-03-30-VA-00-00	3,0mm	1.4301
NL	SD-46x20-08-03-40-VA-00-00	4,0mm	1.4301
NL	SD-46x20-08-03-50-VA-00-00	5,0mm	1.4301

Shimpaket (SDP) Werkstoff: **Edelstahl (VA)**

NL	SDP-46x20-08-03-30-VA-00-00	3,0mm	1.4301
bestehend aus: 1x 0,1/ 2x 0,2/ 3x 0,5/ 1x 1,0 mm			

Shimpaket (SDP) Werkstoff: **Edelstahl (VA)**

NL	SDP-46x20-08-03-50-VA-00-00	5,0mm	1.4301
bestehend aus: 1x 0,1/ 2x 0,2/ 3x 0,5/ 1x 1,0/ 1x 2,0 mm			

Shimblech (S) Werkstoff: **Stahl (ST)**

NL	SD-46x20-08-03-05-ST-00-00	0,5mm	DC01
NL	SD-46x20-08-03-10-ST-00-00	1,0mm	DC01
NL	SD-46x20-08-03-20-ST-00-00	2,0mm	DC01
NL	SD-46x20-08-03-30-ST-00-00	3,0mm	DC01
NL	SD-46x20-08-03-40-ST-00-00	4,0mm	DC01
L	SD-46x20-08-03-50-ST-00-00	5,0mm	DC01

Shimpaket (SDP) Werkstoff: **Stahl (ST)**

NL	SDP-46x20-08-03-30-ST-00-00	3,0mm	DC01
bestehend aus: 1x 0,1/ 2x 0,2/ 3x 0,5/ 1x 1,0 mm			

Shimpaket (SDP) Werkstoff: **Stahl (ST)**

NL	SDP-46x20-08-03-50-ST-00-00	5,0mm	DC01
bestehend aus: 1x 0,1/ 2x 0,2/ 3x 0,5/ 1x 1,0/ 1x 2,0 mm			

01.01 Shim-Abstimmplatten

Shim m. Durchgang (SD)
ShimDurchgangpaket (SDP)

50x20-08-03

L = lagernd
NL = nicht lagernd

L/NL Bestellnummer **Dicke** **Werkstoff**

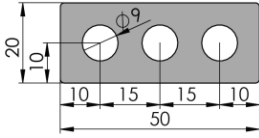

Shimblech (SD) Werkstoff: **Edelstahl (VA)**

NL	SD-50x20-08-03-005-VA-00-00	0,05mm	1.4310
NL	SD-50x20-08-03-01-VA-00-00	0,1mm	1.4310
NL	SD-50x20-08-03-02-VA-00-00	0,2mm	1.4310
NL	SD-50x20-08-03-05-VA-00-00	0,5mm	1.4301
NL	SD-50x20-08-03-10-VA-00-00	1,0mm	1.4301
NL	SD-50x20-08-03-20-VA-00-00	2,0mm	1.4301
NL	SD-50x20-08-03-30-VA-00-00	3,0mm	1.4301
NL	SD-50x20-08-03-40-VA-00-00	4,0mm	1.4301
NL	SD-50x20-08-03-50-VA-00-00	5,0mm	1.4301

Shimpaket (SDP) Werkstoff: **Edelstahl (VA)**

NL	SDP-50x20-08-03-30-VA-00-00	3,0mm	1.4301
bestehend aus: 1x 0,1/ 2x 0,2/ 3x 0,5/ 1x 1,0 mm			

Shimpaket (SDP) Werkstoff: **Edelstahl (VA)**

NL	SDP-50x20-08-03-50-VA-00-00	5,0mm	1.4301
bestehend aus: 1x 0,1/ 2x 0,2/ 3x 0,5/ 1x 1,0/ 1x 2,0 mm			

Shimblech (S) Werkstoff: **Stahl (ST)**

NL	SD-50x20-08-03-05-ST-00-00	0,5mm	DC01
NL	SD-50x20-08-03-10-ST-00-00	1,0mm	DC01
NL	SD-50x20-08-03-20-ST-00-00	2,0mm	DC01
NL	SD-50x20-08-03-30-ST-00-00	3,0mm	DC01
NL	SD-50x20-08-03-40-ST-00-00	4,0mm	DC01
L	SD-50x20-08-03-50-ST-00-00	5,0mm	DC01

Shimpaket (SDP) Werkstoff: **Stahl (ST)**

NL	SDP-50x20-08-03-30-ST-00-00	3,0mm	DC01
bestehend aus: 1x 0,1/ 2x 0,2/ 3x 0,5/ 1x 1,0 mm			

Shimpaket (SDP) Werkstoff: **Stahl (ST)**

NL	SDP-50x20-08-03-50-ST-00-00	5,0mm	DC01
bestehend aus: 1x 0,1/ 2x 0,2/ 3x 0,5/ 1x 1,0/ 1x 2,0 mm			

01.01 Shim-Abstimmplatten

Shim m. Durchgang (SD)
ShimDurchgangpaket (SDP)

65x16-08-04

L = lagernd
NL = nicht lagernd

L/NL Bestellnummer **Dicke** **Werkstoff**

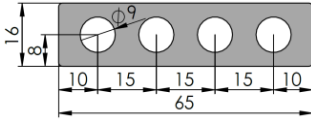

Shimblech (SD) Werkstoff: **Edelstahl (VA)**

NL	SD-65x16-08-04-005-VA-00-00	0,05mm	1.4310
NL	SD-65x16-08-04-01-VA-00-00	0,1mm	1.4310
NL	SD-65x16-08-04-02-VA-00-00	0,2mm	1.4310
NL	SD-65x16-08-04-05-VA-00-00	0,5mm	1.4301
NL	SD-65x16-08-04-10-VA-00-00	1,0mm	1.4301
NL	SD-65x16-08-04-20-VA-00-00	2,0mm	1.4301
NL	SD-65x16-08-04-30-VA-00-00	3,0mm	1.4301
NL	SD-65x16-08-04-40-VA-00-00	4,0mm	1.4301
NL	SD-65x16-08-04-50-VA-00-00	5,0mm	1.4301

Shimpaket (SDP) Werkstoff: **Edelstahl (VA)**

NL	SDP-65x16-08-04-30-VA-00-00	3,0mm	1.4301
bestehend aus: 1x 0,1/ 2x 0,2/ 3x 0,5/ 1x 1,0 mm			

Shimpaket (SDP) Werkstoff: **Edelstahl (VA)**

NL	SDP-65x16-08-04-50-VA-00-00	5,0mm	1.4301
bestehend aus: 1x 0,1/ 2x 0,2/ 3x 0,5/ 1x 1,0/ 1x 2,0 mm			

Shimblech (S) Werkstoff: **Stahl (ST)**

NL	SD-65x16-08-04-05-ST-00-00	0,5mm	DC01
NL	SD-65x16-08-04-10-ST-00-00	1,0mm	DC01
NL	SD-65x16-08-04-20-ST-00-00	2,0mm	DC01
NL	SD-65x16-08-04-30-ST-00-00	3,0mm	DC01
NL	SD-65x16-08-04-40-ST-00-00	4,0mm	DC01
L	SD-65x16-08-04-50-ST-00-00	5,0mm	DC01

Shimpaket (SDP) Werkstoff: **Stahl (ST)**

NL	SDP-65x16-08-04-30-ST-00-00	3,0mm	DC01
bestehend aus: 1x 0,1/ 2x 0,2/ 3x 0,5/ 1x 1,0 mm			

Shimpaket (SDP) Werkstoff: **Stahl (ST)**

NL	SDP-65x16-08-04-50-ST-00-00	5,0mm	DC01
bestehend aus: 1x 0,1/ 2x 0,2/ 3x 0,5/ 1x 1,0/ 1x 2,0 mm			

01.01 Shim-Abstimmplatten

Shim m. Durchgang (SD)
ShimDurchgangpaket (SDP)

65x20-08-04

L = lagernd

NL = nicht lagernd

L/NL Bestellnummer

Dicke

Werkstoff

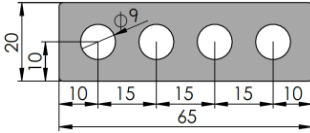

		Shimblech (SD)	Werkstoff: Edelstahl (VA)		
NL	SD-65x20-08-04-005-VA-00-00			0,05mm	1.4310
NL	SD-65x20-08-04-01-VA-00-00			0,1mm	1.4310
NL	SD-65x20-08-04-02-VA-00-00			0,2mm	1.4310
NL	SD-65x20-08-04-05-VA-00-00			0,5mm	1.4301
NL	SD-65x20-08-04-10-VA-00-00			1,0mm	1.4301
L	SD-65x20-08-04-20-VA-00-00			2,0mm	1.4301
NL	SD-65x20-08-04-30-VA-00-00			3,0mm	1.4301
L	SD-65x20-08-04-40-VA-00-00			4,0mm	1.4301
NL	SD-65x20-08-04-50-VA-00-00			5,0mm	1.4301

		Shimpaket (SDP)	Werkstoff: Edelstahl (VA)		
NL	SDP-65x20-08-04-30-VA-00-00			3,0mm	1.4301
		bestehend aus: 1x 0,1/ 2x 0,2/ 3x 0,5/ 1x 1,0 mm			

		Shimpaket (SDP)	Werkstoff: Edelstahl (VA)		
NL	SDP-65x20-08-04-50-VA-00-00			5,0mm	1.4301
		bestehend aus: 1x 0,1/ 2x 0,2/ 3x 0,5/ 1x 1,0/ 1x 2,0 mm			

		Shimblech (S)	Werkstoff: Stahl (ST)		
NL	SD-65x20-08-04-05-ST-00-00			0,5mm	DC01
NL	SD-65x20-08-04-10-ST-00-00			1,0mm	DC01
NL	SD-65x20-08-04-20-ST-00-00			2,0mm	DC01
NL	SD-65x20-08-04-30-ST-00-00			3,0mm	DC01
NL	SD-65x20-08-04-40-ST-00-00			4,0mm	DC01
L	SD-65x20-08-04-50-ST-00-00			5,0mm	DC01

		Shimpaket (SDP)	Werkstoff: Stahl (ST)		
NL	SDP-65x20-08-04-30-ST-00-00			3,0mm	DC01
		bestehend aus: 1x 0,1/ 2x 0,2/ 3x 0,5/ 1x 1,0 mm			

		Shimpaket (SDP)	Werkstoff: Stahl (ST)		
NL	SDP-65x20-08-04-50-ST-00-00			5,0mm	DC01
		bestehend aus: 1x 0,1/ 2x 0,2/ 3x 0,5/ 1x 1,0/ 1x 2,0 mm			

01.01 Shim-Abstimmplatten

Shim m. Durchgang (SD)
ShimDurchgangpaket (SDP)

50x50-08-09

L = lagernd
NL = nicht lagernd

L/NL Bestellnummer **Dicke** **Werkstoff**

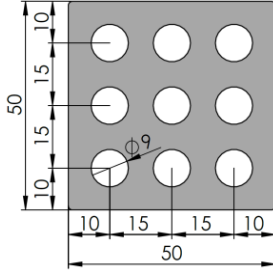

Shimblech (SD) Werkstoff: **Edelstahl (VA)**

NL	SD-50x50-08-09-005-VA-00-00	0,05mm	1.4310
NL	SD-50x50-08-09-01-VA-00-00	0,1mm	1.4310
NL	SD-50x50-08-09-02-VA-00-00	0,2mm	1.4310
NL	SD-50x50-08-09-05-VA-00-00	0,5mm	1.4301
NL	SD-50x50-08-09-10-VA-00-00	1,0mm	1.4301
NL	SD-50x50-08-09-20-VA-00-00	2,0mm	1.4301
NL	SD-50x50-08-09-30-VA-00-00	3,0mm	1.4301
NL	SD-50x50-08-09-40-VA-00-00	4,0mm	1.4301
NL	SD-50x50-08-09-50-VA-00-00	5,0mm	1.4301

Shimpaket (SDP) Werkstoff: **Edelstahl (VA)**

NL	SDP-50x50-08-09-30-VA-00-00	3,0mm	1.4301
----	------------------------------------	--------------	--------

bestehend aus:
1x 0,1/ 2x 0,2/ 3x 0,5/ 1x 1,0 mm

Shimpaket (SDP) Werkstoff: **Edelstahl (VA)**

NL	SDP-50x50-08-09-50-VA-00-00	5,0mm	1.4301
----	------------------------------------	--------------	--------

bestehend aus:
1x 0,1/ 2x 0,2/ 3x 0,5/ 1x 1,0/ 1x 2,0 mm

Shimblech (S) Werkstoff: **Stahl (ST)**

NL	SD-50x50-08-09-05-ST-00-00	0,5mm	DC01
NL	SD-50x50-08-09-10-ST-00-00	1,0mm	DC01
NL	SD-50x50-08-09-20-ST-00-00	2,0mm	DC01
L	SD-50x50-08-09-30-ST-00-00	3,0mm	DC01
L	SD-50x50-08-09-40-ST-00-00	4,0mm	DC01
L	SD-50x50-08-09-50-ST-00-00	5,0mm	DC01

Shimpaket (SDP) Werkstoff: **Stahl (ST)**

NL	SDP-50x50-08-09-30-ST-00-00	3,0mm	DC01
----	------------------------------------	--------------	------

bestehend aus:
1x 0,1/ 2x 0,2/ 3x 0,5/ 1x 1,0 mm

Shimpaket (SDP) Werkstoff: **Stahl (ST)**

NL	SDP-50x50-08-09-50-ST-00-00	5,0mm	DC01
----	------------------------------------	--------------	------

bestehend aus:
1x 0,1/ 2x 0,2/ 3x 0,5/ 1x 1,0/ 1x 2,0 mm

01.01 Shim-Abstimmplatten

Shim m. Durchgang (SD)
ShimDurchgangpaket (SDP)

D19-d8,2

Abmaße identisch
Audi / VW - Norm:
39D 20638/ 1

L = lagernd

NL = nicht lagernd

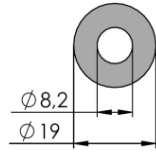

L/NL	Bestellnummer	Dicke	Werkstoff
	Shimblech (SD) Werkstoff: Edelstahl (VA)		
NL	SD-D19-d8,2-005-VA-00-00	0,05mm	1.4310
L	SD-D19-d8,2-01-VA-00-00	0,1mm	1.4310
L	SD-D19-d8,2-02-VA-00-00	0,2mm	1.4310
NL	SD-D19xd8,2-05-VA-00-00	0,5mm	1.4301
NL	SD-D19-d8,2-10-VA-00-00	1,0mm	1.4301
NL	SD-D19-d8,2-20-VA-00-00	2,0mm	1.4301
NL	SD-D19-d8,2-30-VA-00-00	3,0mm	1.4301
NL	SD-D19-d8,2-40-VA-00-00	4,0mm	1.4301
NL	SD-D19-d8,2-50-VA-00-00	5,0mm	1.4301
	Shimpaket (SDP) Werkstoff: Edelstahl (VA)		
NL	SDP-D19-d8,2-30-VA-00-00 bestehend aus: 1x 0,1/ 2x 0,2/ 3x 0,5/ 1x 1,0 mm	3,0mm	1.4301
NL	SDP-D19-d8,2-50-VA-00-00 bestehend aus: 1x 0,1/ 2x 0,2/ 3x 0,5/ 1x 1,0/ 1x 2,0 mm	5,0mm	1.4301
	Shimblech (S) Werkstoff: Stahl (ST)		
L	SD-D19-d8,2-05-ST-00-00	0,5mm	DC01
L	SD-D19-d8,2-10-ST-00-00	1,0mm	DC01
L	SD-D19-d8,2-20-ST-00-00	2,0mm	DC01
NL	SD-D19-d8,2-30-ST-00-00	3,0mm	DC01
NL	SD-D19-d8,2-40-ST-00-00	4,0mm	DC01
L	SD-D19-d8,2-50-ST-00-00	5,0mm	DC01
	Shimpaket (SDP) Werkstoff: Stahl (ST)		
L	SDP-D19-d8,2-30-ST-00-00 bestehend aus: 1x 0,1/ 2x 0,2/ 3x 0,5/ 1x 1,0 mm	3,0mm	DC01
L	SDP-D19-d8,2-50-ST-00-00 bestehend aus: 1x 0,1/ 2x 0,2/ 3x 0,5/ 1x 1,0/ 1x 2,0 mm	5,0mm	DC01

Abmaße identisch
Audi / VW - Norm:
39D 20638/ 2

01.01 Shim-Abstimmplatten

Shim m. Durchgang (SD)
ShimDurchgangpaket (SDP)

D49-d10,2

L = lagernd
NL = nicht lagernd

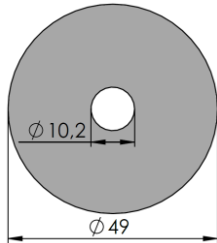

L/NL	Bestellnummer	Dicke	Werkstoff
Shimblech (SD) Werkstoff: Edelstahl (VA)			
NL	SD-D49-d10,2-005-VA-00-00	0,05mm	1.4310
L	SD-D49-d10,2-01-VA-00-00	0,1mm	1.4310
L	SD-D49-d10,2-02-VA-00-00	0,2mm	1.4310
NL	SD-D49-d10,2-05-VA-00-00	0,5mm	1.4301
NL	SD-D49-d10,2-10-VA-00-00	1,0mm	1.4301
NL	SD-D49-d10,2-20-VA-00-00	2,0mm	1.4301
NL	SD-D49-d10,2-30-VA-00-00	3,0mm	1.4301
NL	SD-D49-d10,2-40-VA-00-00	4,0mm	1.4301
NL	SD-D49-d10,2-50-VA-00-00	5,0mm	1.4301
Shimpaket (SDP) Werkstoff: Edelstahl (VA)			
NL	SDP-D49-d10,2-30-VA-00-00	3,0mm	1.4301
	bestehend aus: 1x 0,1/ 2x 0,2/ 3x 0,5/ 1x 1,0 mm		
NL	SDP-D49-d10,2-50-VA-00-00	5,0mm	1.4301
	bestehend aus: 1x 0,1/ 2x 0,2/ 3x 0,5/ 1x 1,0/ 1x 2,0 mm		
Shimblech (S) Werkstoff: Stahl (ST)			
L	SD-D49-d10,2-05-ST-00-00	0,5mm	DC01
L	SD-D49-d10,2-10-ST-00-00	1,0mm	DC01
L	SD-D49-d10,2-20-ST-00-00	2,0mm	DC01
NL	SD-D49-d10,2-30-ST-00-00	3,0mm	DC01
NL	SD-D49-d10,2-40-ST-00-00	4,0mm	DC01
L	SD-D49-d10,2-50-ST-00-00	5,0mm	DC01
L	SDP-D49-d10,2-30-ST-00-00	3,0mm	DC01
	bestehend aus: 1x 0,1/ 2x 0,2/ 3x 0,5/ 1x 1,0 mm		
L	SDP-D49-d10,2-50-ST-00-00	5,0mm	DC01
	bestehend aus: 1x 0,1/ 2x 0,2/ 3x 0,5/ 1x 1,0/ 1x 2,0 mm		



Beliebige Kombinationsmöglichkeiten:

Shim-System-08-03

08 = für Gewindegröße M8
03 = 3 Bohrungen pro Anschraubfläche

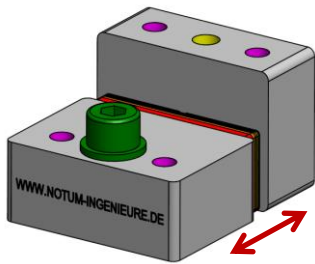

X-Achse einstellbar

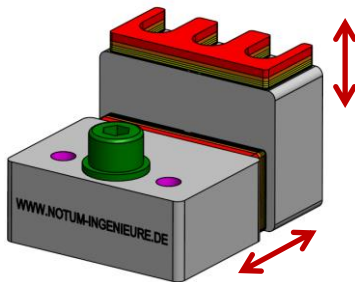

X-Z-Achse einstellbar

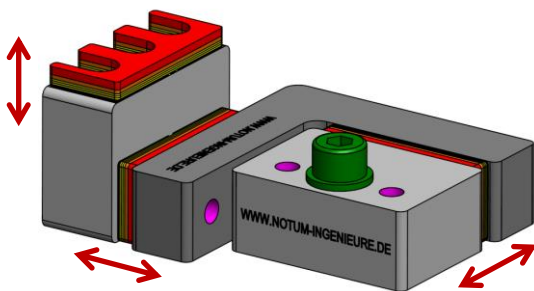

X-Y-Z-Achse einstellbar

Weitere Kombinationsbeispiele:

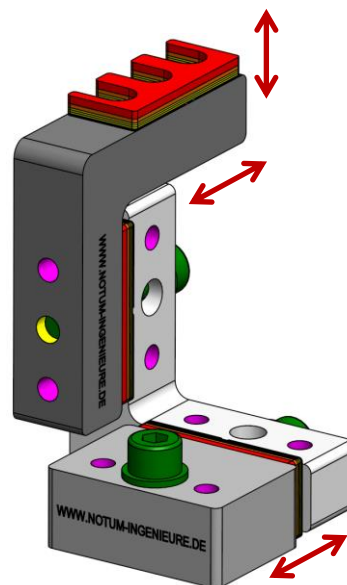
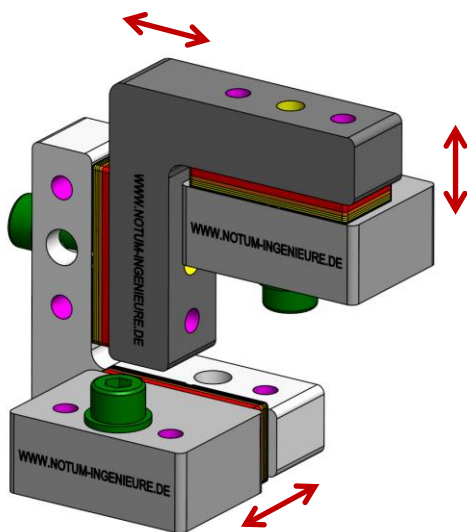

Weitere Produkte:

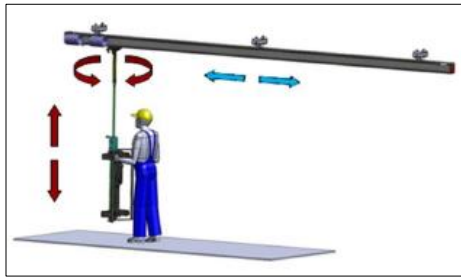
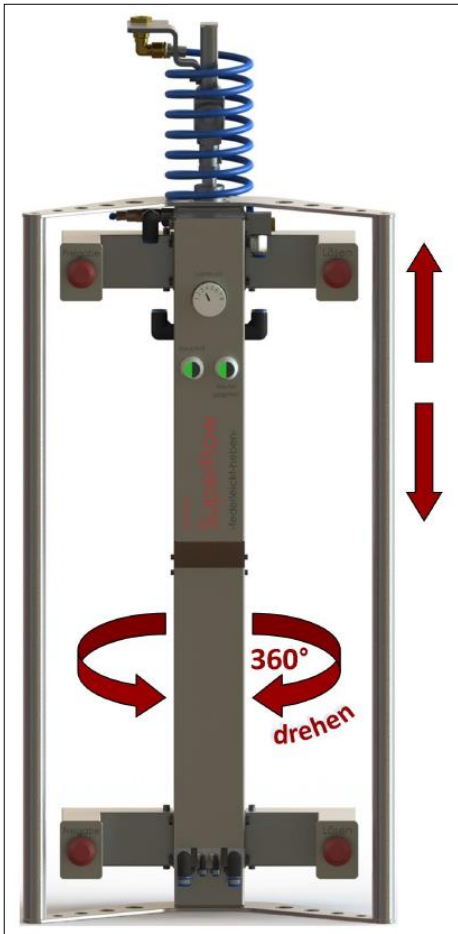

SuperFlow Balancer

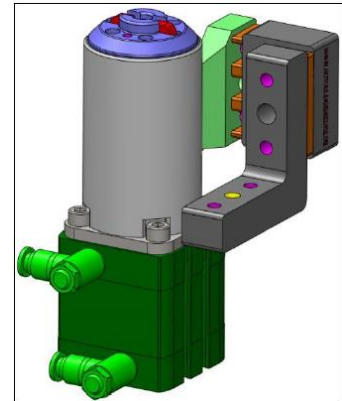
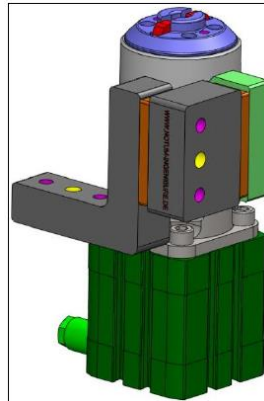

Prozesssichere Unterzugspanneinheiten

Wünschen Sie weitere Informationen, dann fordern Sie unsere ausführliche Preisliste an.

“ lass dich **gut beraten**, bevor du beginnst;
 doch wenn du dich entschieden hast,
handle sofort “

-Sallust-

Alle Preise sind Nettopreise zuzüglich der gesetzlich gültigen Mehrwertsteuer.

Lieferzeit: 3-4 Werktage bei Standardteilen, bei großen Bestellmengen nach Absprache.
 Lieferbedingungen: EXW Schernfeld Incoterms 2000

Fehler und Irrtümer sind ausdrücklich vorbehalten.
 Es gelten unsere allgemeinen Geschäftsbedingungen, einzusehen unter www.notum-ingenieure.de